



VIGYAN
ASHRAM

UV CABINET

for Sanitization of Daily Use objects

PREVENTION FROM COVID 19

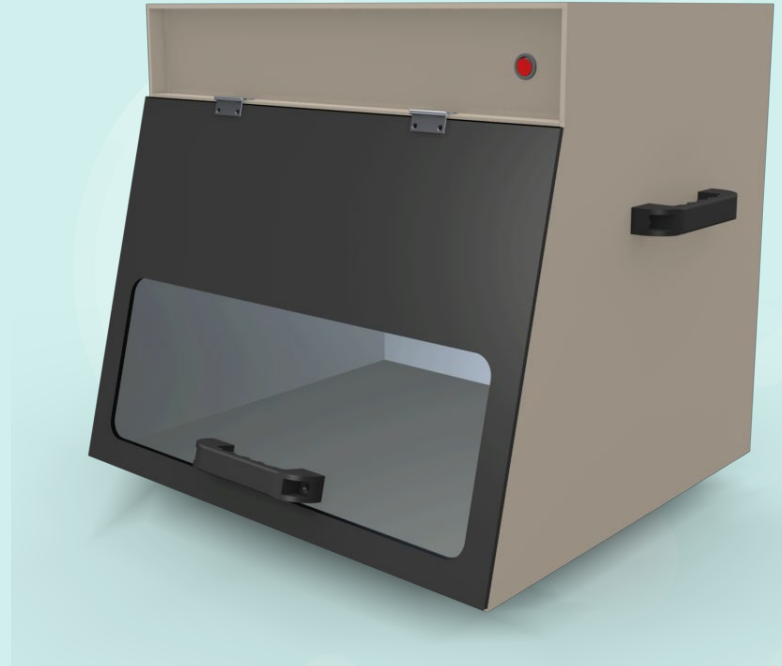

Supported by:

EAT•N

Powering Business Worldwide

**DS DASSAULT
SYSTEMES**

— La Fondation —

Index

1	Introduction	3 - 4
2	Purpose of Project	5 - 7
3	Product Description	8
4	Features	9
5	Bill of materials	10
6	Parts to make	11
7	Parts for purchase	12
8	Tools Required	13
9	Safety Instructions for assembly	14 - 15
10	Process of assembly	16 - 33
11	Commissioning of System: Safety for usage	34
12	Maintenance of System	35
13	Disclaimer	36

Introduction



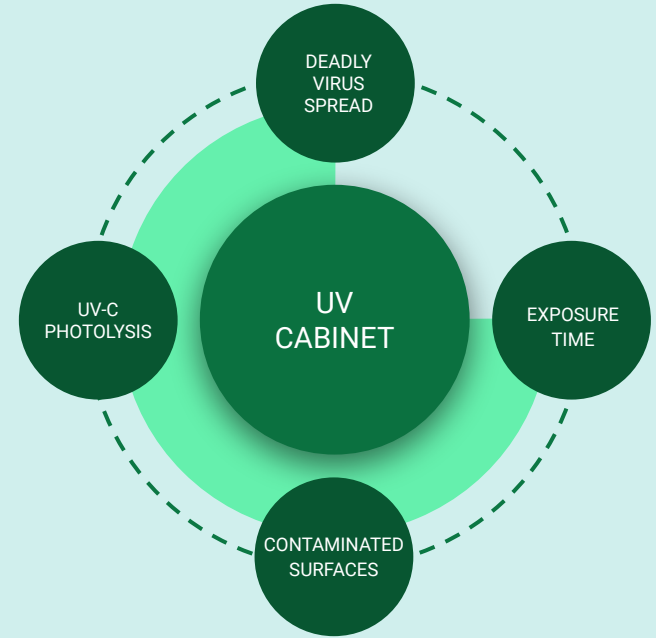

Contaminated surfaces spread viruses. Viruses can persist on surfaces like metal, glass, or plastic for upto a couple of days.

Therefore, contaminated surfaces that are frequently contacted in day-to-day life are a potential source of coronavirus transmission.

Unlike other techniques, UV-C photolysis rarely produces potentially dangerous by-products. Air has a low absorption coefficient and hence allows UV-C to attack microorganisms present.



How does UV-C destroy germs?

Source of contamination	Contaminated surfaces that are frequently contacted in day to day life are a potential source of SARS-CoV, MERS-CoV or HCoV transmission	
Daily Usables	Laptops, mobile phones, coffee mugs, pencils, pens, medical devices, card swipe machines, ID cards, diaries and many other day-to-day objects	
UV-C Light	Use of UV-C light allows for disinfection. The high energy from short wavelength UV-C light is absorbed in the cellular RNA and DNA, damaging nucleic acids and preventing microorganisms from infecting and reproducing	
Application	Right dose for right amount of time exposure of UV-C rays kills almost 99% bacteria and inactivates virus like Covid-19, salmonella, influenza, and more	

Purpose of project

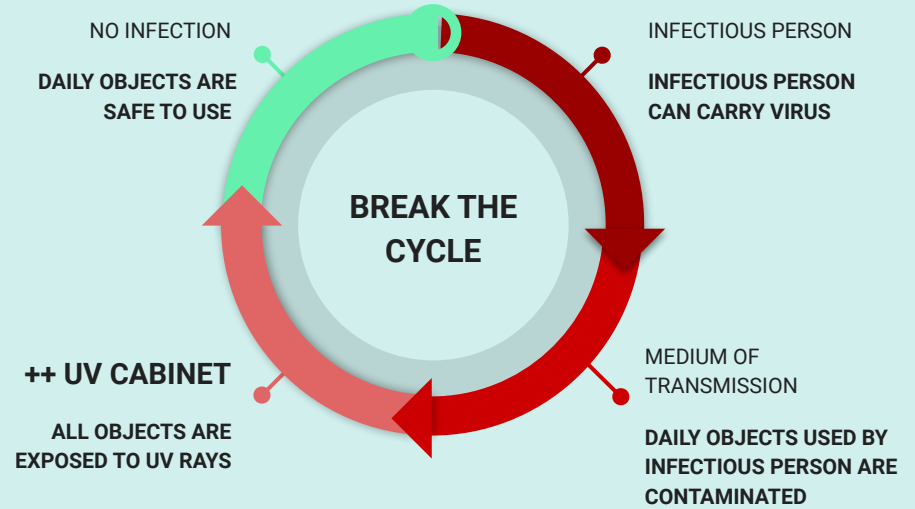
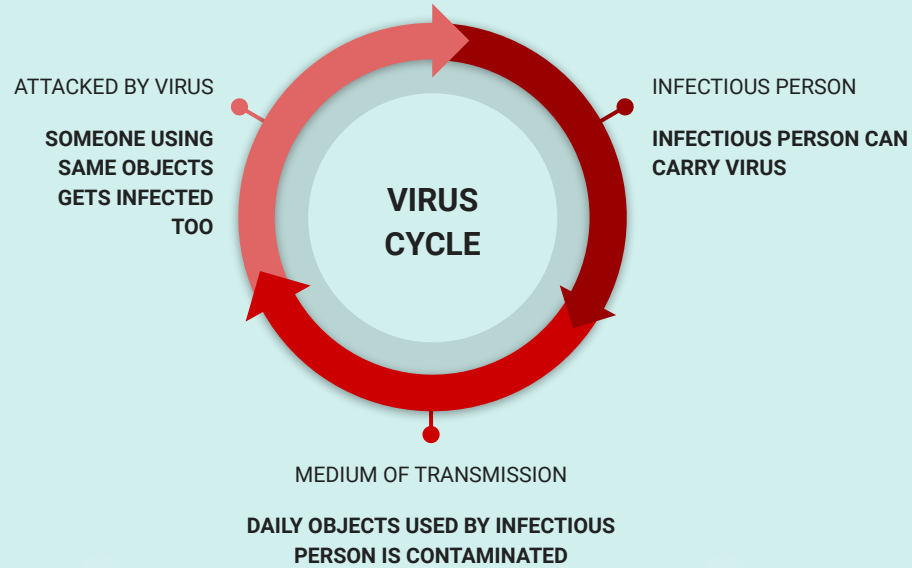

Product Description

UV CABINET- PREVENTION FROM COVID 19

The UV cabinet is a compact multi functional disinfecting machine. A cabinet box with ample space made to disinfect day to day objects. Utilities are exposed to the high energy from short wavelength UV-C light. The light is absorbed in the cellular RNA and DNA, damaging nucleic acids and preventing microorganisms from infecting and reproducing.

Once the objects are kept in the cabinet; the door is closed and power button is switched ON. After 3 minutes of UV light exposure, one has to switch OFF power. The objects inside the cabinet are disinfected and ready to use now. This machine is portable, user friendly and cost effective.

The manufacturing process is very simple; the material used is standard and easily available in local market. It is made up of a box of plywood with a closing door enclosing a transparent acrylic sheet. The power button and warning procedure is applied on front face of unit. There are two UV lights installed inside of cabinet and electrical wiring are kept under the top panel. Power specifications are as xxxxxxx.

Features

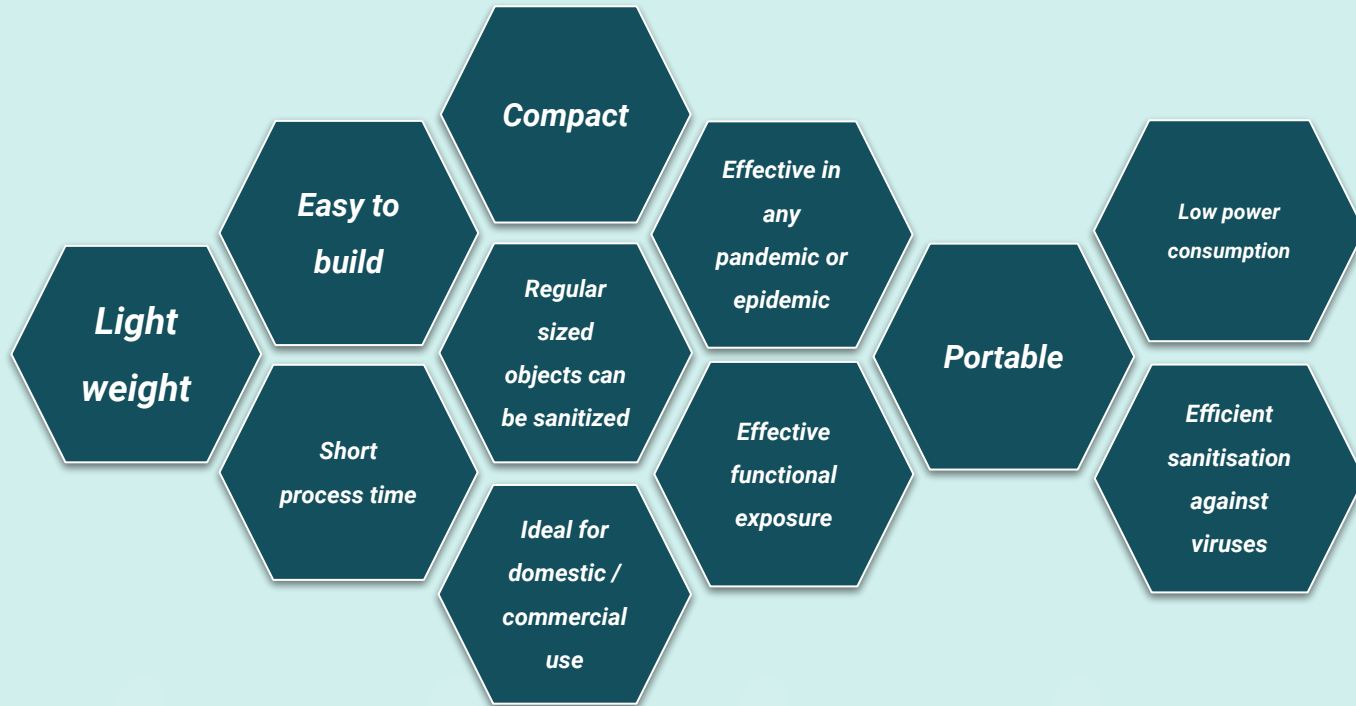

OVERVIEW

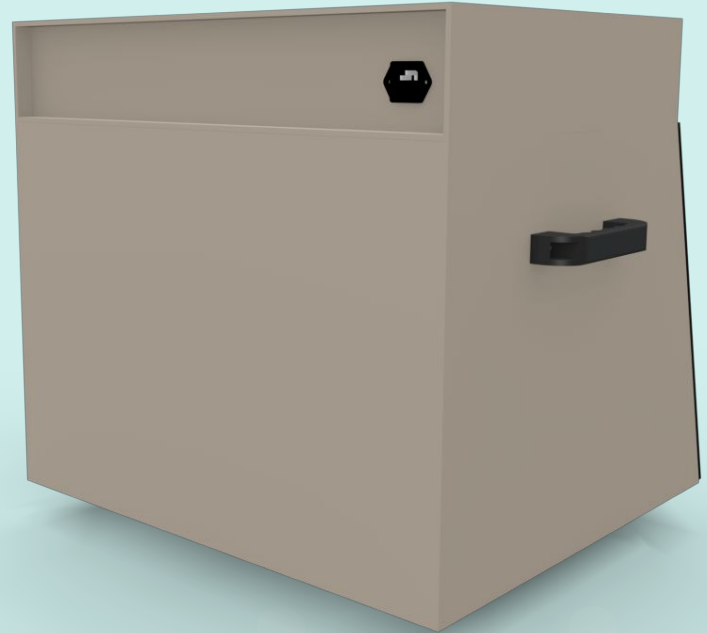
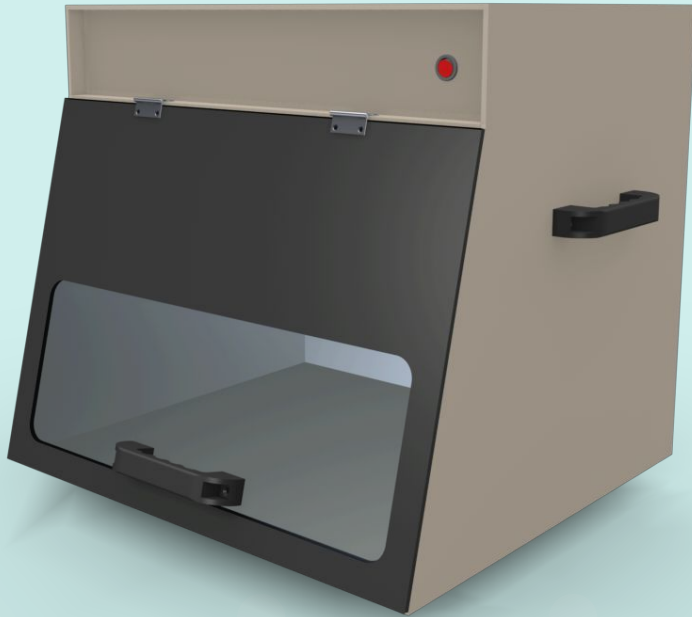

UV CABINET

Bill of Materials (BOM)

Sr. No.	Material Description	Specifications	Quantity
1	Plywood	6mm (8ft x 4ft)	1
2	UV- C type	11 W	2
3	AC UV choke	Model :160 Input: 110-300 V AC 50/60 Hz	2
4	Indicator Switch	Input: 250 V , 6A	1
5	AC Female Connector	Input: 250 V , 10/16A	1
6	Tube holder flat plate (M.S.)	309mm * 40mm* 1.5mm (l*b*t)	2
7	Tube holder cap (ABS)	44.5 mm * 35mm (d*l)	4
8	Nut and bolts	M5 * 20mm	8
9	Aluminium Foil	550 mm * 400 mm (l*h)	1
10	Aluminium Foil	400 mm * 400 mm (l*h)	4
11	Wood primer/ Paint	1 litre	1
12	Wood adhesive	250gm	1
13	Handles	Smooth - no sharp edges	3
14	Electrical wiring cable	Length – 2m	1

Parts Overview

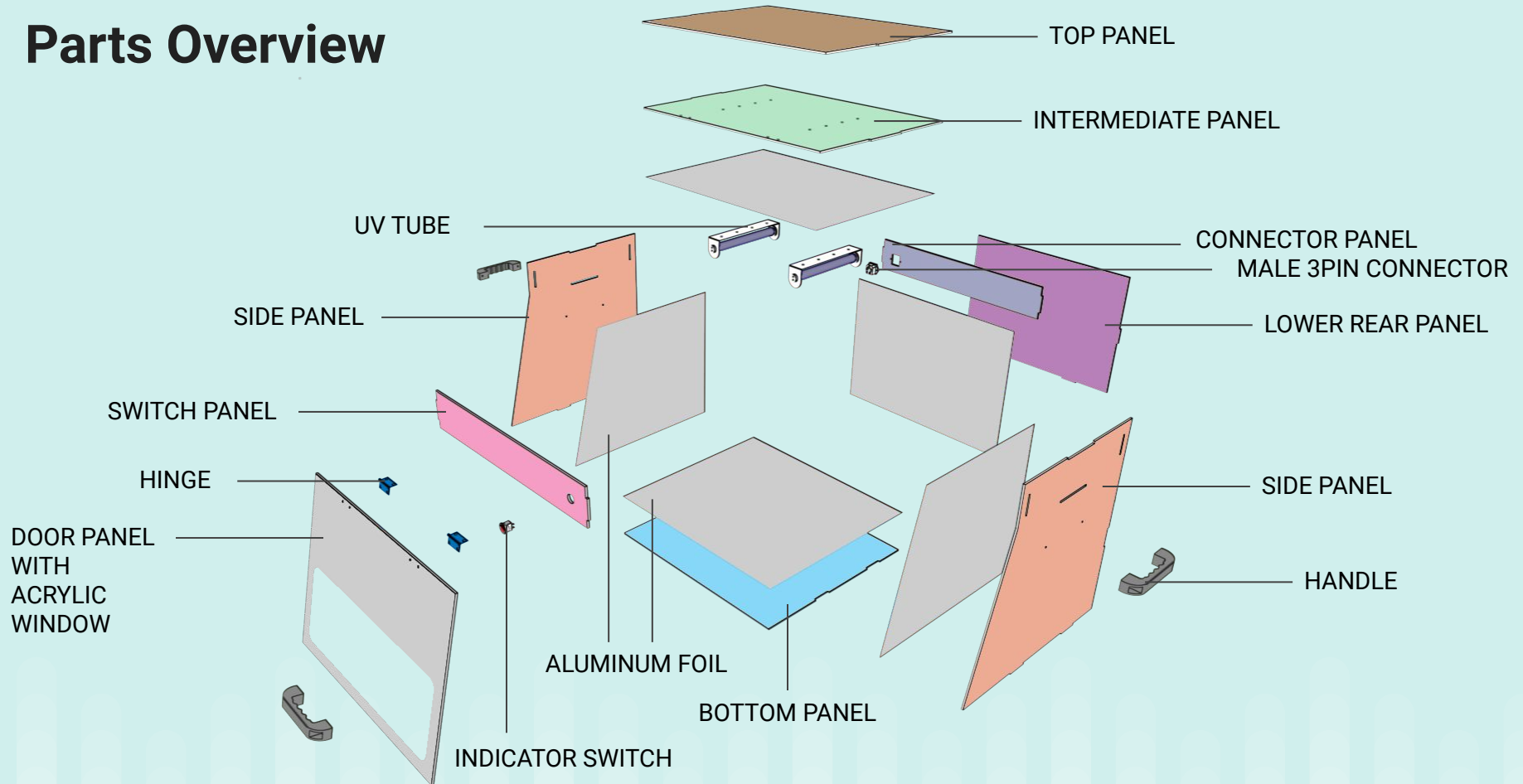

Parts to Make

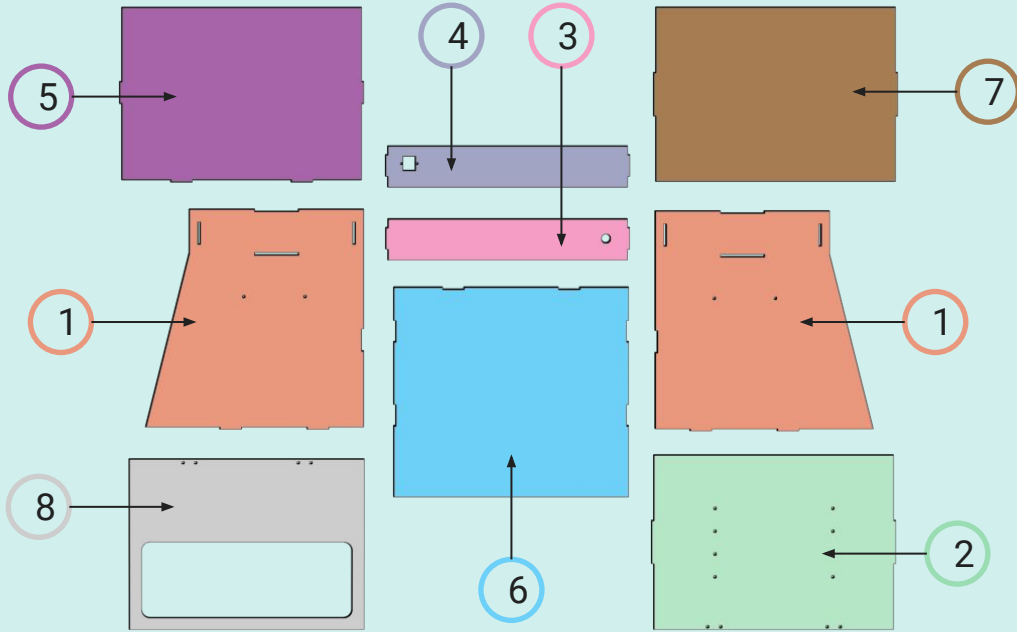

No.	Part Name	Drg. Ref (pdf)
1	Slide Panel	VA2020-P001-00-0003
2	Intermediate Panel	VA2020-P001-00-0004
3	Switch Panel	VA2020-P001-00-0006
4	Connector Panel	VA2020-P001-00-0005
5	Back Panel	VA2020-P001-00-0002
6	Base Panel	VA2020-P001-00-0001
7	Top Panel	VA2020-P001-00-0007
8	Door Panel	VA2020-P001-00-0008

Parts to Purchase

No	Part Name	Qty
1	UV Tube (11W)	2
2	Door Handle	3
3	Door Hinges	2
4	Indicator Switch	1
5	3 Pin Male Connector	1
6	3 Pin Female Connector	1

<https://docs.google.com/spreadsheets/d/144tS0NpXcWCEifTEfzpNCThftDdvpcotGXN9kRZBzHE/edit#gid=0>

Tools required

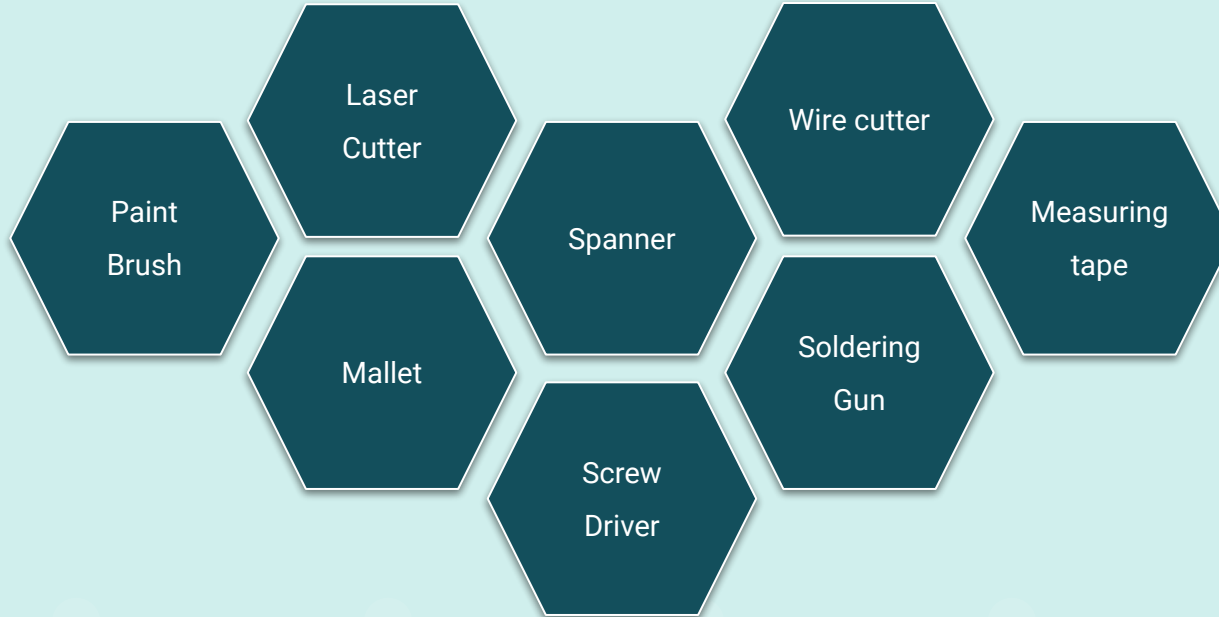

Safety Instructions : For Assembly

Always Wear Safety Equipment

This might seem like a common sense kind of rule, but it's an important one to remember. During usage of loud power tools like routers and surface planers, wearing ear protection is a noted advantage. Similarly, wear latex gloves while applying finishes. Never be without your safety glasses. These should be the first thing you reach for when entering the shop.

Avoid Using Anything That Can Impair Your Reaction Time and Judgement

It's like when you're driving a car: you want to stay out of the alcohol and drug cabinets to avoid accidents. In the wood shop, the dangers are even higher by inadvertently using the wrong tool because you're too out of it to see what you are doing wrong. Never mix alcohol with work, even if it's just a beer.

Wear The Right Clothes

The problem with wearing baggy or loose clothes is the very high chance that a part of them might get caught in a cutting head or saw blade. As a result, try to always wear clothes that are a better match for the woodworking environment, but also protect you. Always ensure that any dangling jewelry or metal such as chains or bracelets, are removed before commencing work.

Safety Instructions : For Assembly

Disconnect Power

Always remember to disconnect the power source itself before changing blades or bits on your power tools. In addition to ensuring the switch is off, make sure there is no electricity being powered to the tool, since the switch can malfunction and/or accidentally get turned on.

Use A Single Extension Cord

Using one heavy duty extension cord for all your power tools will ensure that you switch off the power for each tool. Too many cords can get confusing and be a tripping hazard.

Never Use Blunt Blades & Bits

While this might seem obvious seeing as how dangerous a dull cutting tool can be. Dull tools will need to be made to work harder to cut and as a result can bind or kick back. Sharp bits and blades will ensure cleaner cuts as well.

Flowchart | Process of Assembly -1

Cabinet box
sheet cutting

Step 1

Cutting design intent
sheet

Step 2

Adding self/press fitting
features in pre-cut sheet

Step 3

Adding electrical,
mounting and UV tube
bracket feature holes,
slot, etc

Step 4

Cutting see-through
window slot in
door/closing panel for
acrylic

Flowchart | Process of Assembly -1

Attaching accessories to ready to fit sheet

Step 1

Partition panel sub assembly with side panels

Step 2

Adding lower rear panel

Step 3

Adding bottom panel

Step 4

Make connections with male connector power supply to UV tube circuit

Step 5

Make connections with indicator switch

Step 6

Adding top panel

Step 7

Gluing aluminum foils inside cabinet

Step 8

Attaching door to UV cabinet

Process of Assembly -1

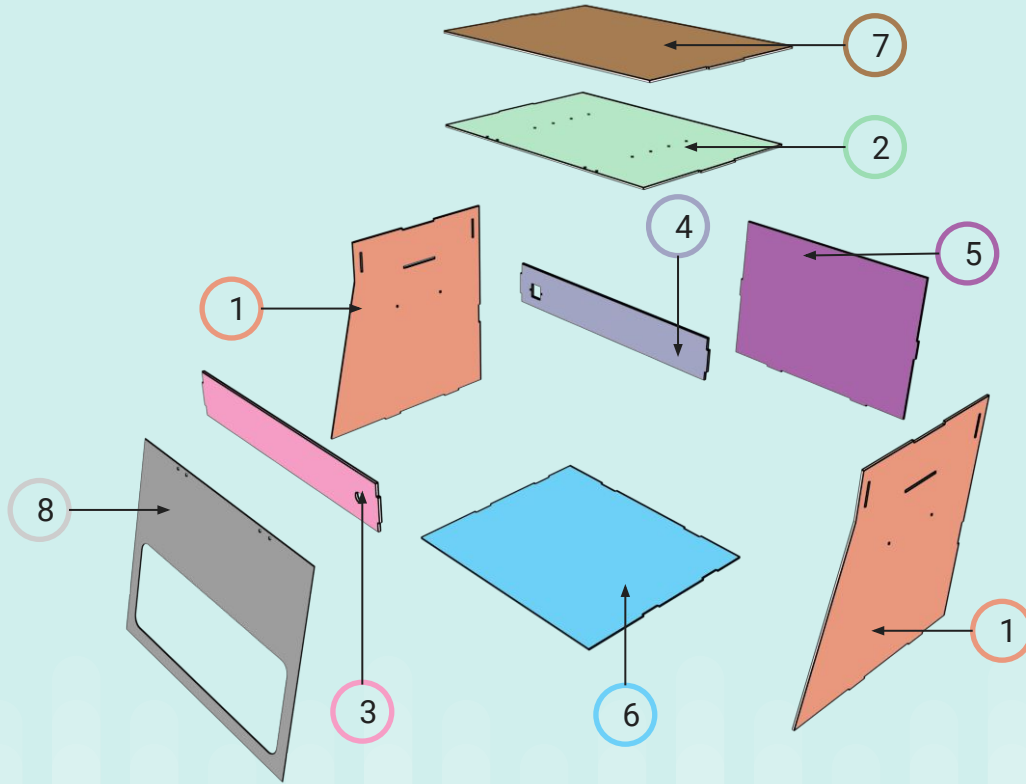

- Cutting design intent sheet
- Adding self/press fitting features in pre-cut sheet
- Adding electrical, mounting and UV tube bracket feature holes, slot, etc.
- Cutting see-through window slot in door/closing panel for acrylic

Flowchart | Process of Assembly -2

Sub
assemblies

Step 1

Front upper panel
sub assembly with
indicator switch

Step 2

Rear panel sub
assembly with male
connector for power
supply

Step 3

Intermediate panel
assembly with UV
tubes

Step 4

Side panels sub
assembly with
handle

Step 5

Front door sub
assembly with
acrylic sheet,
handle and
hinges

Process of Assembly -2

1. Front upper panel sub assembly with indicator switch
2. Rear panel sub assembly with male connector power supply

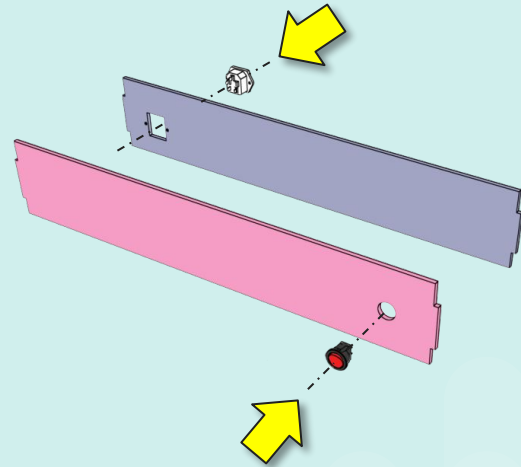

Process of Assembly -2

3. Middle panel assembly with UV tubes

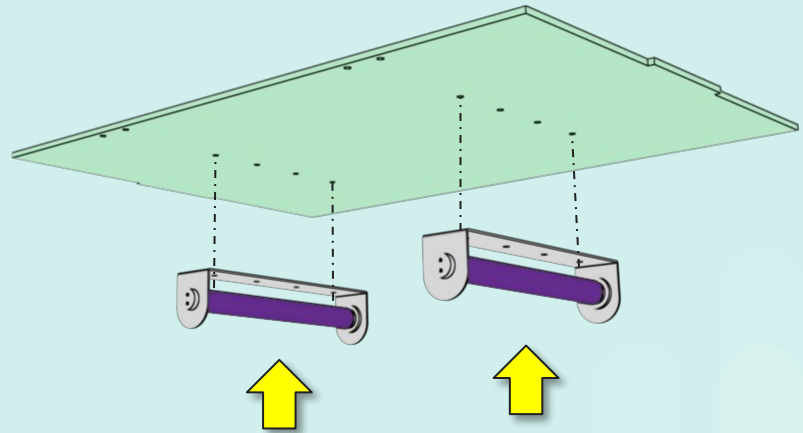

Process of Assembly -2

4. Side panels sub assembly with handle

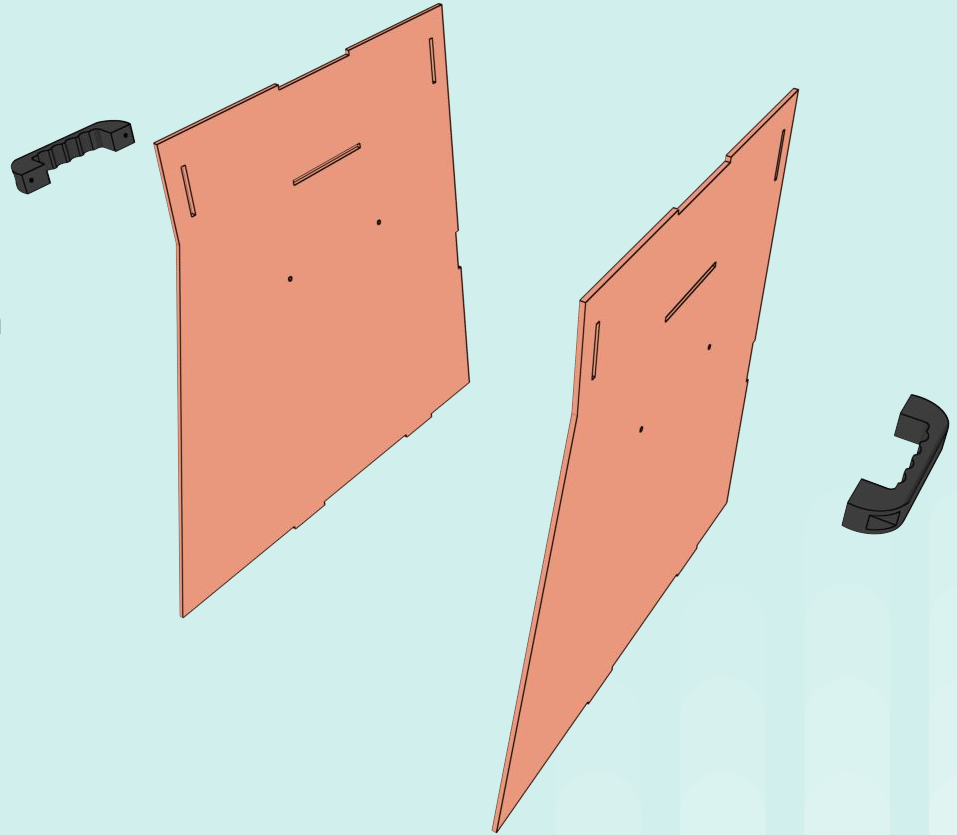

Process of Assembly -2

5. Front door sub assembly with handle, acrylic window, hinges and aluminum foil

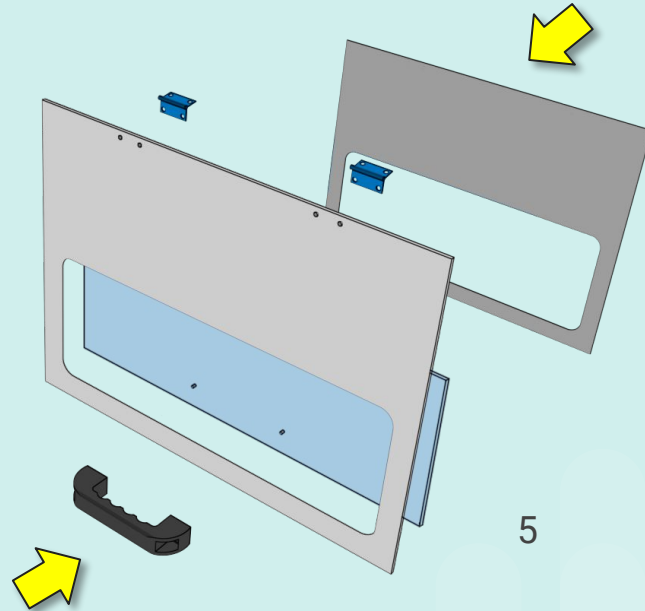

Flowchart | Process of Assembly -3 | Overview

Step 1

Partition panel sub
assy with side panels

Step 2

Adding lower rear
panel

Step 3

Adding bottom panel

Step 4

Make connections with
male connector

Step 5

power supply to UV
tube circuit

Step 6

Make connections with
indicator switch

Step 7

Adding top panel

Step 8

Gluing aluminum foils
inside cabinet

Step 9

Attaching door with UV
cabinet

Process of Assembly -3

Partition panels sub assembly with side panel

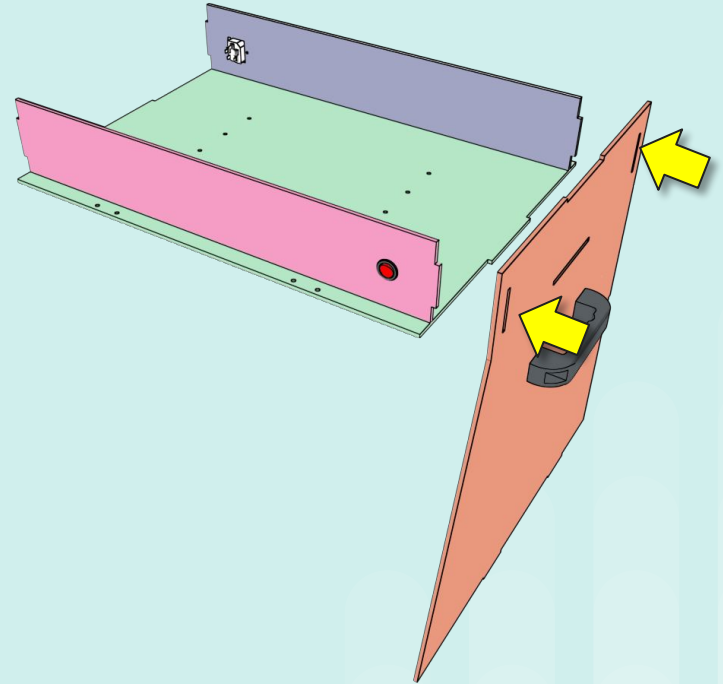

Process of Assembly -3

Partition panel sub assembly with other side panel

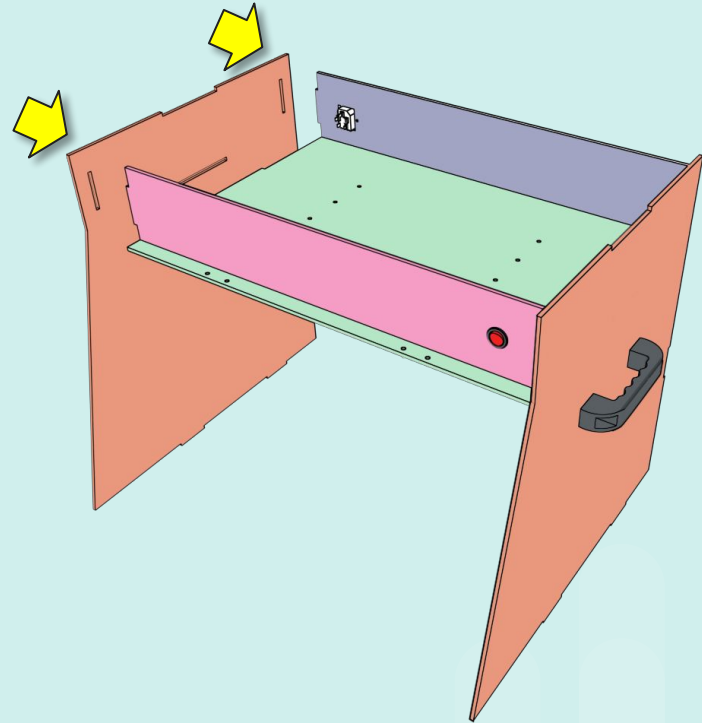

Process of Assembly -3

Adding rear lower panel

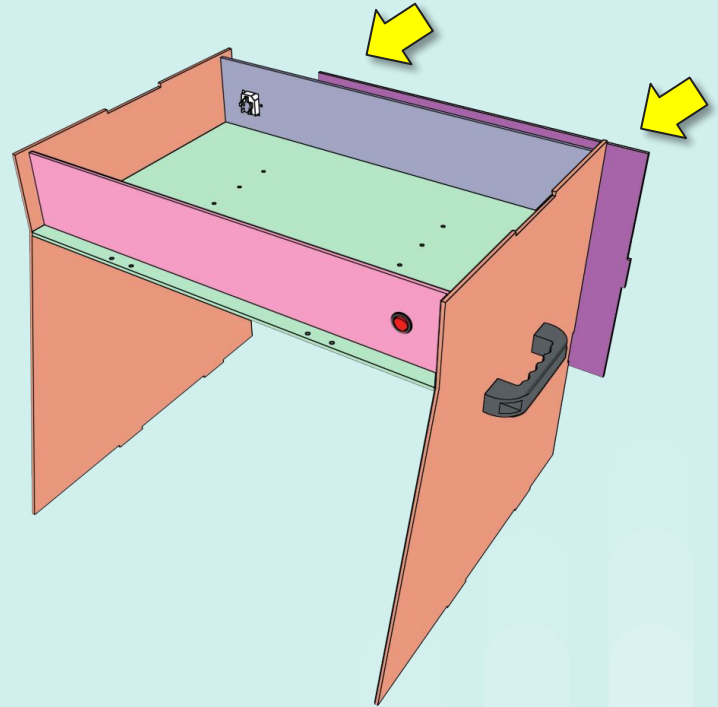

Process of Assembly -3

Adding bottom panel

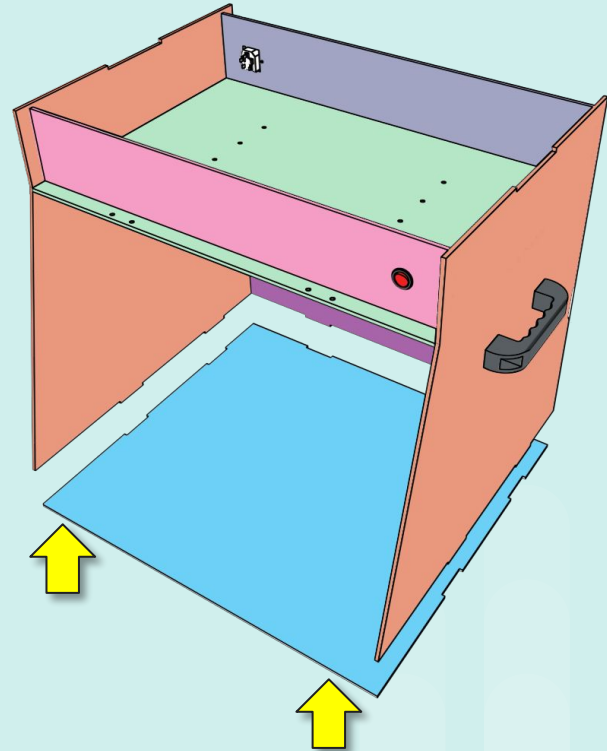

Process of Assembly -3

Make connections with male connector power supply and indicator switch with UV tube wiring

Refer to circuit diagram for details

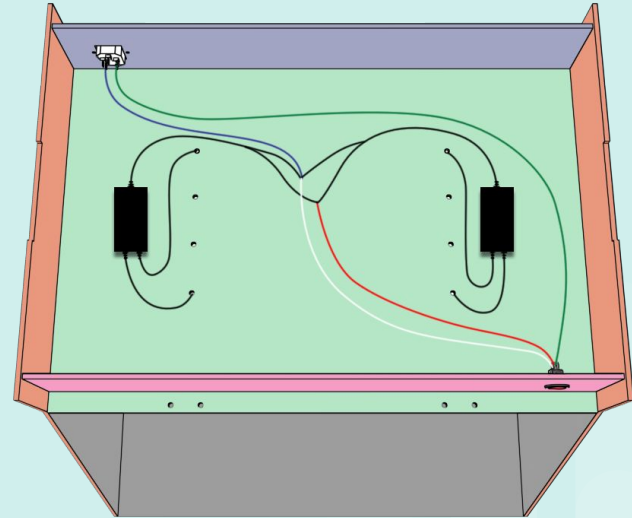

Process of Assembly -3

Adding top panel

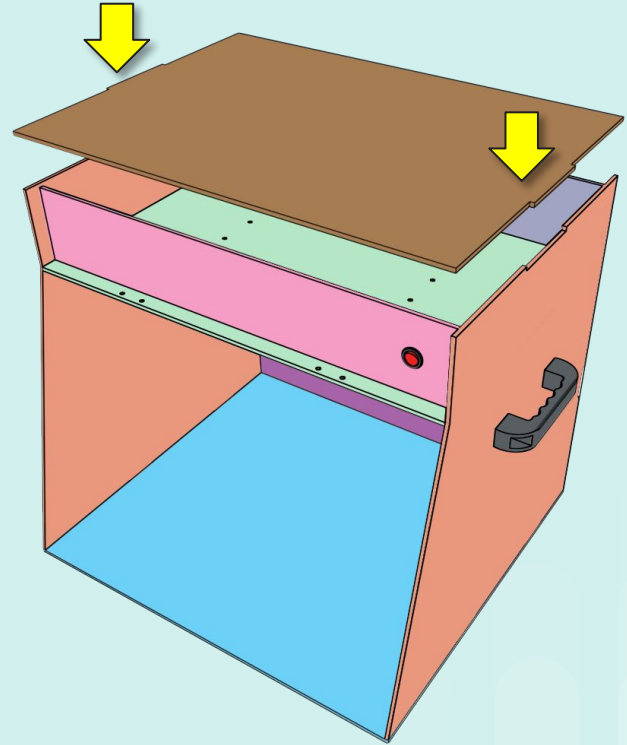

Process of Assembly -3

Gluing aluminum foils inside cabinet

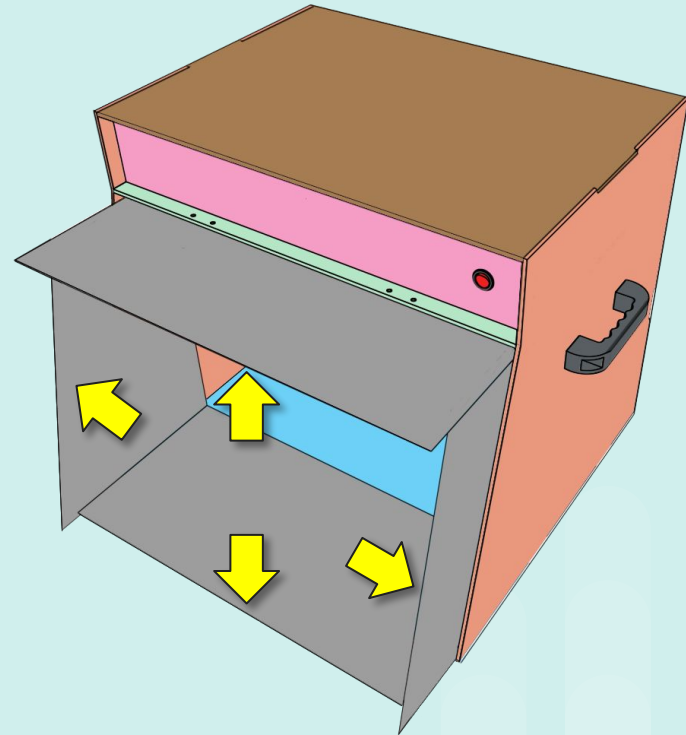

Process of Assembly -3

Adding front panel sub assembly

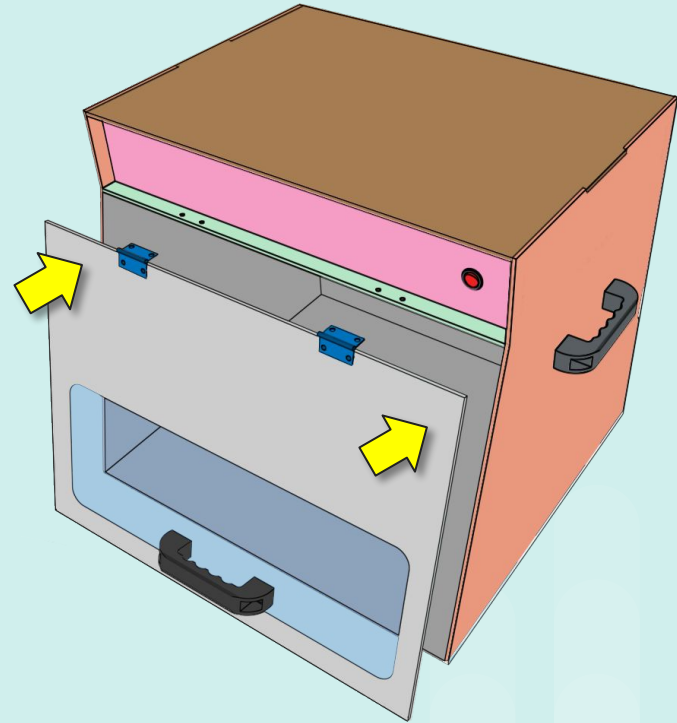

Commissioning of System: Safety for usage

General Instructions

- Press fit parts to assemble the cabinet in an appropriate way
- Ensure that all add-on components are secured in their places
- Ensure that the sufficient/clear space for opening the cabinet door & enough space to access inner area
- Ensure that the Cabinet is placed on a stable surface, ideally on a table. It should be the out of reach from children
- Make sure it is away from damp & wet surfaces, Place the cabinet in a dry area
- Make a Electrical connections properly for UV Tube, three male pin as well as indicator switch with choke circuit
- Ensure that the UV Tubes are functioning without any issue
- Do not expose hand, skin or any body part into the cabinet during operation of UV Tube
- After use of UV Tube please insure that indicator switch is turned OFF

Operational Instructions

- Make sure that the three pin is plugged in and the main switch is ON
- Ensure that the door should be always closed after you placed the items before the indicator switch is turned ON.
- Once the indicator switch is ON, the sanitization process takes 3 min complete.
- Turn OFF the indicator switch after 3 min, before you open the door to retrieve the items..

Maintenance of System

- Check electrical supply & UV tube condition for proper functioning of UV radiation.
- Check the UV tube condition after six months of use (or as recommended by the UV tube manufacturer)
- The UV tube might need to be replaced if blinking happens or tube is fused.
- Disconnect the power supply & clean up the cabinet properly once in a month.
- Checks the hinges are in working condition.

Disclaimer

- The content in this DIY manual is the developed by Vigyan Ashram. All instructions are merely for educational purpose and to create a sharable open source D-I-Y document.
- While the information in this document has been verified to the best of our abilities, we cannot guarantee the performance. All the observations and data are taken from various experiments on system at Vigyan Ashram.
- We reserve the right to change the design. Please contact our website or our expert team for any clarification.

Thank you