



Do-It-Yourself Manual

SOLAR UV WATER FILTER



Supported by:



Powering Business Worldwide



INDEX

1. Introduction
2. Purpose of Project
3. Safety Instructions
4. Product Description
5. Features
6. Parts for purchase
7. Tools Required
8. How does it work? – SOLAR UV WATER FILTER
9. Step by Step Installation
10. Commissioning of System
11. Maintenance System
12. Disclaimer

1. Introduction

Vigyan Ashram has designed & developed a “Portable Solar UV Water Filter” for small houses/ bungalows. Users of the manual will be able to build their own Hydroponics Structure using this manual. All the Bills of Materials (BOM) and dimensions of the systems are given in the design. We have provided design files drawn using Solidworks along with this manual. Users are suggested to read the manual carefully along with the site conditions before fabrication of the unit.

Please watch following video carefully:

- <https://www.youtube.com/watch?v=uO9X4ZMqHzU>

2. Purpose of Manual

- To share standardized design of Portable UV Filter suitable for small bungalows, houses, schools and institutes.
- Design to be made available online for local fabricators to build Portable UV Filter for their customers.



3. Safety Instructions

During fabrication of the system we should use safety equipment such as hand gloves, and glasses.



Safety parameters

- UVC light is hazardous to eyes and human skin, don't open filter cover without turning OFF power supply.
- Fragile material inside, handle filter unit carefully.
- Filter uses 230V AC supply, takes care of electrical connections and checks it in regular time intervals.
- During maintenance disconnect all electrical connections.
- Disconnect power supply while pouring water.
- Keep this unit away from children's reach.

(And as appropriate)

4. Product Description

This is a Portable UV Filter. This system can be deployed in the kitchen, no construction needed. System consists of a 20L storage tank, submersible UV tube of 11 W. The proposed system is able to filter the water at a time.

The detail view and BOM are shown in below:

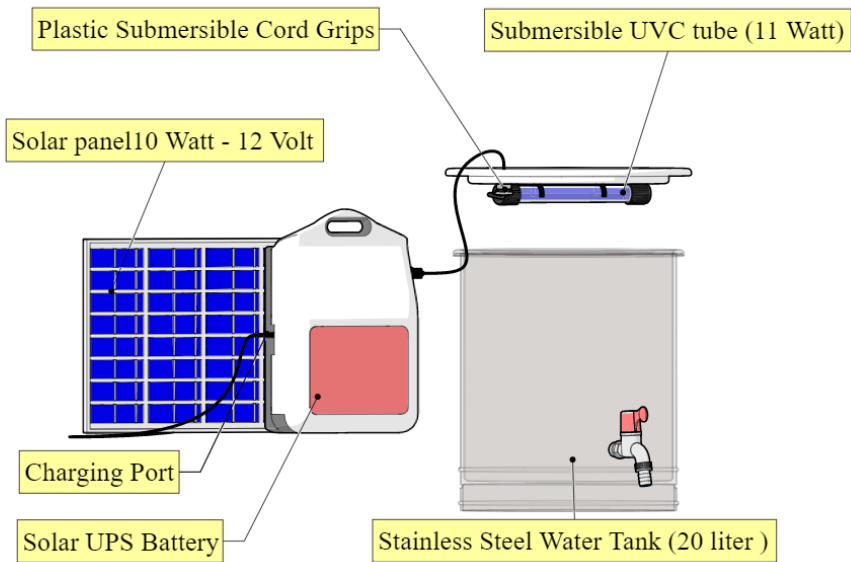

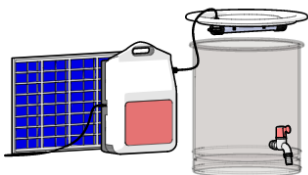
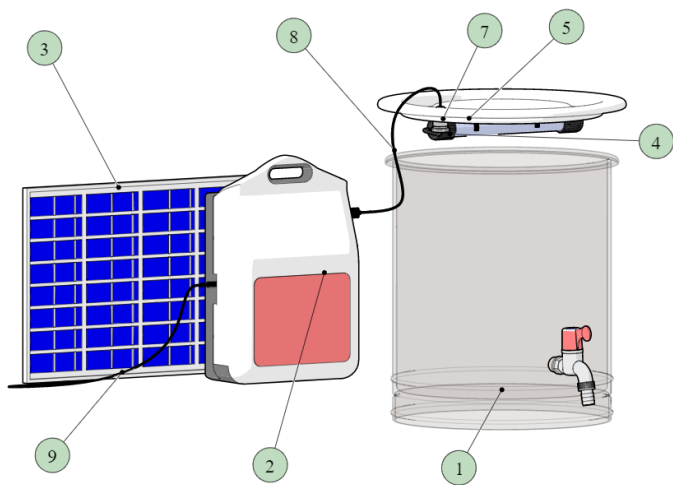

BOM ID	Description	Qty
1	Stainless Steel Water Tank (20 liter)	1
2	Solar UPS Battery	1
3	Solar panel 10 Watt - 12 Volt	1
4	Submersible UVC tube (11 Watt)	1
5	clamp	1
6	clamp	1
7	Plastic Submersible Cord Grips(M12)	1
8	Two pin wire from UV tube	1
9	10W Solar Charging wire	1

5. Features

- Portable water filter / Easy to handle
- Low cost
- Less maintenance / Easy cleaning
- Operates on Grid and Solar Power
- Low power consumption

6. Parts for purchase & Tools Required

Sr. No.	Part Name	Dimensions	Materials	Qty.	Specification
1	Stainless Steel Water Tank (20 liter)	350mm	Steel	1	20L storage tank Load Capacity - 20g
2	Submersible UVC tube (11 Watt)	240mm	Glass	1	Wattage - 11W Voltage: EU: AC220-240V; US: AC110-120V
3	Water Tap	1/2", 15 mm	PVC Plastic	1	Suitable For Kitchen, Wash Basins, Bathroom etc. Easy to Clean
4	UV tube holder	30mm	Plastic	2	Easy to Hold
5	Wire Glance	30mm	Plastic	1	Brand - dharmi Electrical PG 29 Adjustable Nylon gland

6	Solar Panel	28.5cm*35cm	Plastic	1	Brand-LOOM Solar 10 Watt - 12 Volt
7	Battery	30cm*30cm	Plastic	1	Rated Capacity: 45W DC 45W CFL/LED Bulb Solar UPS Main Unit

Sr. No.	Tool	Image
1.	Drill Machine	

7. How it works? - Solar UV Water Filter

This UV filter unit is very handy to use, just follow below steps to start using this.

- Open a filter cover and keep this aside, cover it with UVC tube (fragile material), take care during handling.
- Pour tap water inside up to marking. (Take care of this while selecting water source - This filter removing only bacterial content, it's not reducing water hardness or filters muddy water)
- Keep filter cover on tank, orient tube inside direction.
- Now plug in the filter connection in the 230V AC socket and turn ON switch.
- Keep this for next 15-20 min.
- Turn OFF switch and remove connection. Water is ready to drink.
- Keep the filter ON every day for 15-20 min.

Advantages:

- This filter uses UVC light radiations in bandwidth 200 to 280nm to kill pathogens inside water in a batch process. It requires around 15-20 minutes for 20 liter water.
- No need to give continuous supply. Very less electricity consumption, 11 watt / hour.
- Portable unit works on solar power, for remote area users, for tribal communities.
- No need for an extra tank, motor and solenoids like continuous type of filters.
- Low cost, affordable to tribal, remote area peoples.
- Takes very less space and is handy to use and clean.

Disadvantages:

- It's only disinfecting water by killing bacteria and viruses, it's not reducing water hardness.
- Not suitable for muddy water.

8. Process of Assembly

- Step 1: Make Appropriate holes on wall of SS container & its Lid
- Step 2: Fitting a water Tap on wall of container

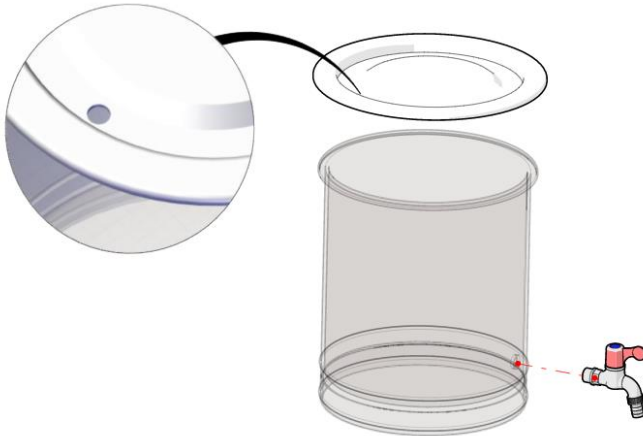

- Step 3: Fitting a Plastic submersible cord grip on a lid

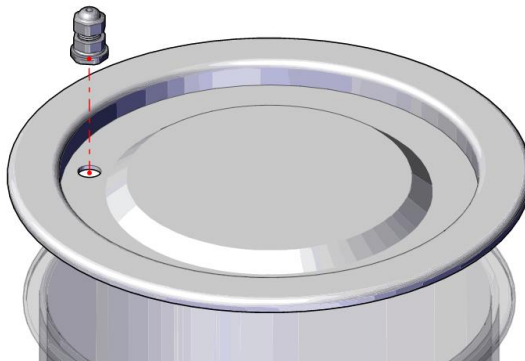

- Step 4: Fitting a Vacuum clamp at bottom of lid at appropriate position.
- Step 5: To assembled Submersible UV-C tube in vacuum clamp.
- Step 6: Wiring connection of UV-C tube through plastic submersible cord grips.

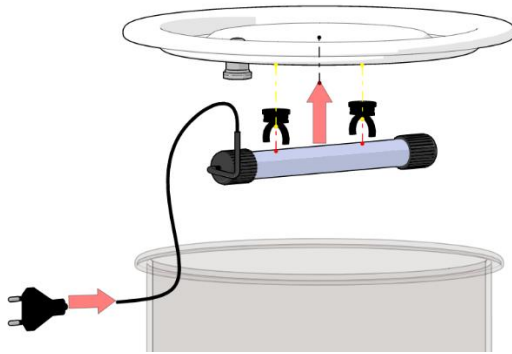

- Step 7: Two pin UV-C tube in plug into solar UPS battery.

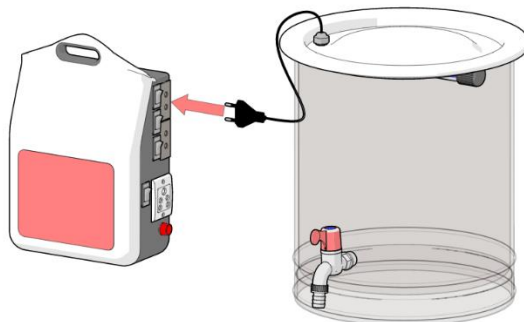

- Step 8: Connection of 10W solar charging wire from solar panel to charging port of UPS battery.

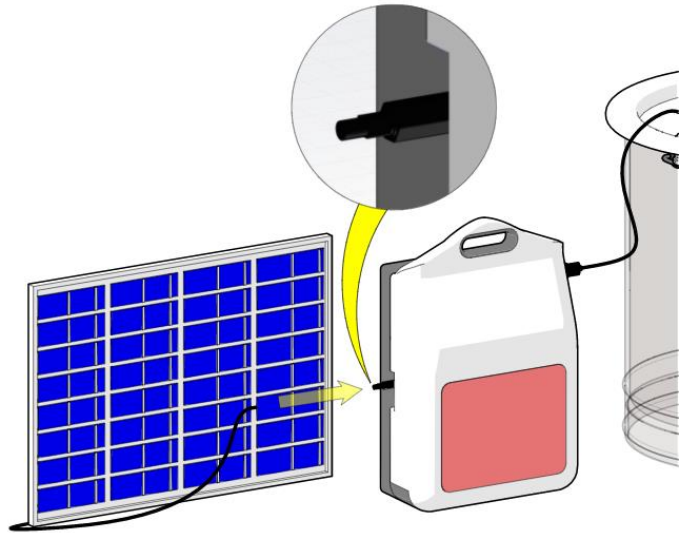

- Complete Assembly

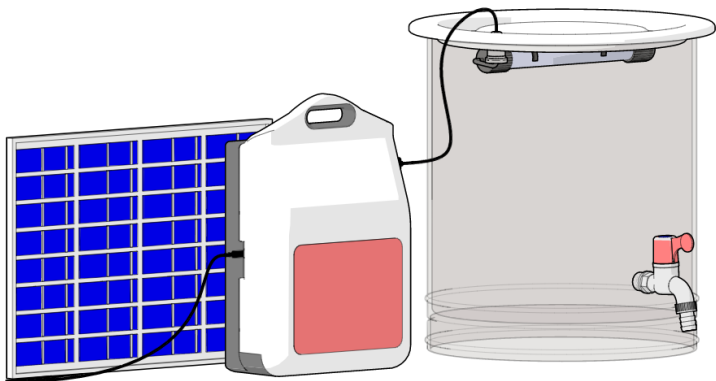

9. Commissioning & Maintenance of system

- Check fragile parts regularly.
- Check electric connections regularly.
- If the tube is not operational don't turn it ON.
- Check water level while filling water.
- Don't open filter cover when its ON
- Fit cover properly after pouring water.
- Fill water up to the marking only.
- Fix UV-C tube properly with vacuum press attachments after cleaning.
- Keep it ON every day for 15 min only, don't leave it ON for the whole day/ night.
- Handle fragile parts carefully.

10. Disclaimer

The content in this DIY manual is developed by Vigyan Ashram. All instructions are merely for educational purpose and to create a sharable open source D-I-Y document.

While the information in this document has been verified to the best of our abilities, we cannot guarantee the performance. All the observation and data are taken from various experiments on system at Vigyan Ashram.

We reserve the right to change the design. Please contact our website or our expert team for any clarification.